

CERTIFICAT OIML DE CONFORMITE
OIML CERTIFICATE OF CONFORMITY

N° R21/2007-FR02-2015/01 rev 2 du 21 octobre 2015

Autorité de délivrance : Laboratoire National de Métrologie et d'Essais
Issuing authority : Personne responsable (Person responsible) : Thomas LOMMATZSCH

Demandeur : AUTOMATISMES ET TECHNIQUES AVANCEES SA - 30 impasse du Nid ZA du
Applicant : Verdalai

Fabricant : AUTOMATISMES ET TECHNIQUES AVANCEES 30 impasse du nid - ZA du Verdalaï
Manufacturer : FRA 13790 PEYNIER

Identification du type certifié : Le taximètre A.T.A. type Révolution
Identification of the certified pattern : taximeter A.T.A. type Revolution

Caractéristiques : les caractéristiques principales de l'instrument sont décrites en annexe au présent
Characteristics : the main characteristics of the instrument are described in the annex of these certificat.

Ce certificat atteste la conformité du modèle mentionné ci-dessus (représenté par les échantillons identifiés dans les rapports d'essais associés) aux exigences de la Recommandation suivante de l'Organisation Internationale de Métrologie Légale – OIML) :

This certificate attests the conformity of the above-mentioned pattern (represented by the samples identified in the associated test reports with the requirements of the following Recommendation of the International Organization of Legal Metrology – OIML) :

OIML R 21 / 2007

Ce certificat s'applique uniquement aux caractéristiques métrologiques et techniques du modèle d'instrument concerné, telles que couvertes par la Recommandation Internationale applicable. Ce certificat ne constitue en rien une approbation internationale à caractère légal. Note importante : à part la mention du numéro de référence du certificat avec le nom de l'Etat Membre de l'OIML dans lequel le certificat a été délivré, une reproduction partielle du certificat ou des rapports d'essais associés n'est pas autorisée, mais ils peuvent être reproduits dans leur totalité.

This certificate relates only to the metrological and technical characteristics of the pattern for the concerned instrument, as covered by the relevant OIML International Recommendation. This certificate does not bestow any form of legal international approval. Important note : Apart from the mention of the certificate's reference number and the name of the OIML Member State in which the certificate was issued, partial quotation of the certificate or the associated test report is not permitted, though they may be reproduced in full.

Les principales caractéristiques figurent dans l'annexe ci-jointe qui fait partie intégrante du certificat OIML de conformité et comprend 15 page(s).

The principal characteristics are set out in the appendix hereto, which forms part of the OIML certificate of conformity and consists of 15 page(s).

Etabli le 16 octobre 2015

Issued on October 16th, 2015

Autorité de délivrance pour Le Directeur Général
Issuing Authority On behalf of the General Director



Thomas LOMMATZSCH
Responsable du Pôle Certification
Measuring Instruments Division Manager

Référence LNE-29209 rév. n° 2

Laboratoire national de métrologie et d'essais

Établissement public à caractère industriel et commercial • Siège social : 1, rue Gaston Boissier - 75724 Paris Cedex 15 • Tél. : 01 40 43 37 00
Fax : 01 40 43 37 37 • E-mail : info@lne.fr • Internet : www.lne.fr • Siret : 313 320 244 00012 • NAF : 743 B • TVA : FR 92 313 320 244
Barclays Paris Centrale IBAN : FR76 3058 8600 0149 7267 4010 170 BIC : BARCFRPP

Annex to the OIML certificate n° R21/2007-FR02-2015/01 rev. 2

Historical

Certificat number	Date	Revision	Object
R21/2007-FR02-2015/01	24 th , April 2015	0	- Initial
R21/2007-FR02-2015/01	09 th , October 2015	1	- Change the value of the taximeter checksum - Possibility to connect an ATA Cardan generator to the taximeter - New appendix added : Appendix 2 Power UP
R21/2007-FR02-2015/01	21 th , October 2015	2	- New appendix added : Appendix 3 Air S Appendix 4 Air W

The last modifications are identified by a line in the margin of the document.

Designation

This instrument can be marketed under different commercial names. It can be equipped with complementary devices not covered by the 2004/22/EC directive.

Characteristics

Voltage supply	:	9 – 16 V
Range of the k constant of the device	:	500 120 000 imp/km
Mechanical environment class	:	M3
Electromagnetic environment class	:	E3
Temperature range	:	-25°C / 70°C

Description

The taximeter ATA type REVOLUTION indicates at any moment, the price to be paid by users depending on the distance covered, how long the vehicle is engaged and the programmed tariffs. The taximeter is composed by two elements: the ATA BOX and the ATA screen being the Human Machine Interface.

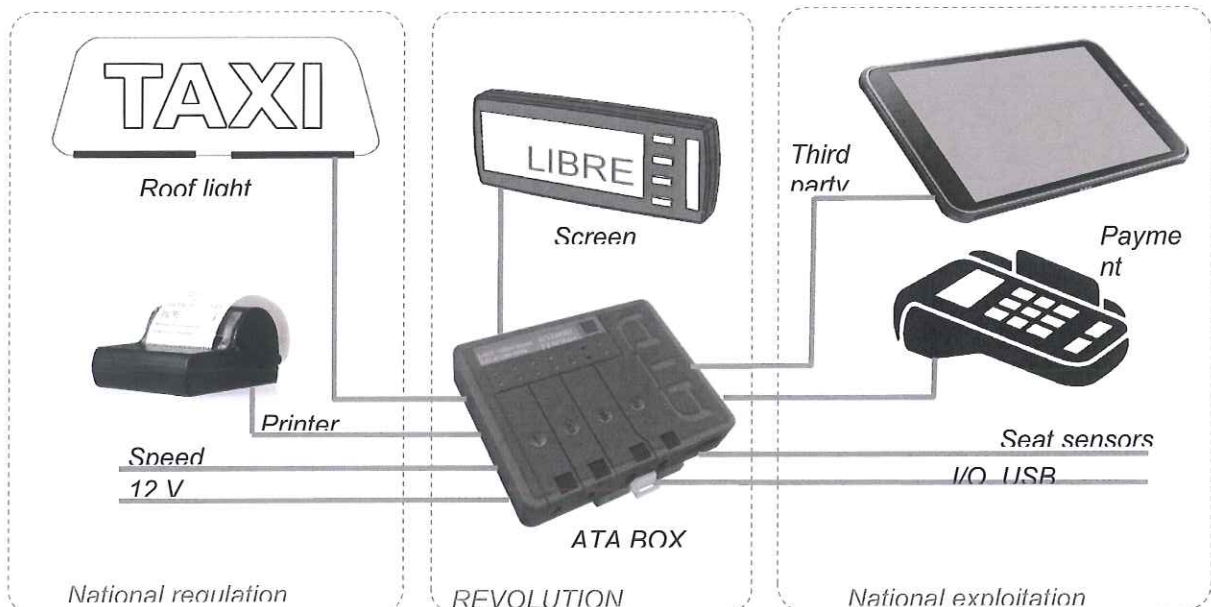

Annex to the OIML certificate n° R21/2007-FR02-2015/01 rev. 2

• ATA BOX

The ATA BOX has got 4 access trap doors. These trap doors provide access to multiple connectors. Depending on the devices to connect, it may be necessary to secure such trap doors by using a seal

The trap door n°4 is for connecting the main regulated devices (roof light, screen, printer, for example). Its access must be systematically protected by a seal.

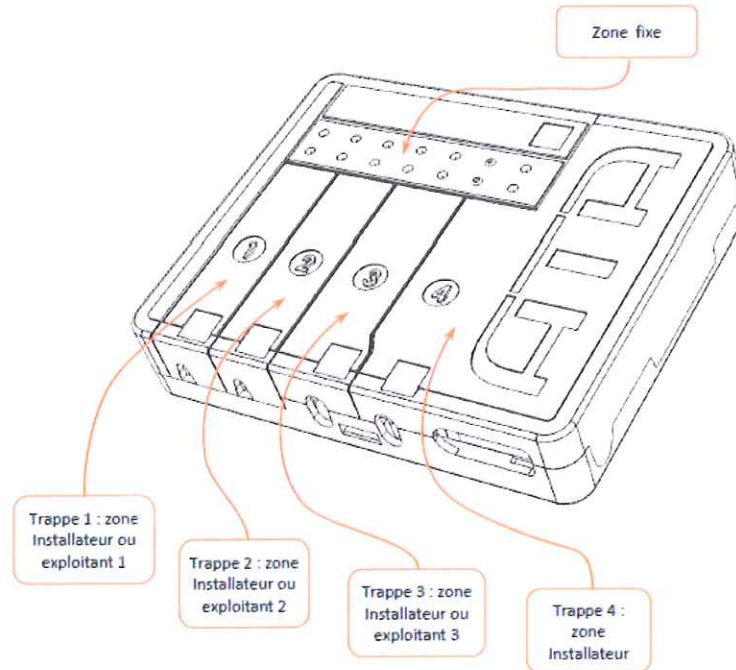

• Screen ATA

The screen ATA is the man-machine interface of the taximeter. It is connected to the ATA BOX by an electric cable. It includes:

- the display,
- the buttons of manipulation by the user,
- a plug to connect the programming device.

Operation

• Journey

To start a journey from the « FOR HIRE » position, it is necessary to push the shift button. Then taximeter switches to « HIRED » mode. In « HIRED » mode, it is possible to switch the tariffs. This position is shown by the mention « FARE ». To stop the journey, it is necessary to push the shift button to the « STOPPED » position. In « STOPPED » position is not possible to switch to « FOR HIRE » position before 10 seconds.

The printing of the journey receipt is possible in « STOPPED » position. In case of abnormality of the printer, the fault is indicated on the screen.

In position « STOPPED », it is possible to display the total cost of the journey, including the supplements, by pushing the "TOTAL" button. After 5 seconds, the taximeter goes back automatically to the « STOPPED » position.

• Management functions

The management functions are accessible by pushing the button « MENU ». The taximeter goes back automatically to the "FREE" position after 10 seconds if no action has been done.

Management functions are, among others:

- display of programmed fares ;
- display of checksums ;
- display of totals (some of them can be deleted) ;
- display test and test of some additional devices connected to the taximeter;
- settings (e.g. standby mode, automatic / manual fare modification).

• Programming

Programming fares and defining the characteristics of the taximeter can be performed by the ATA's programming tool or by a pad fitted with the ATA's programming software.

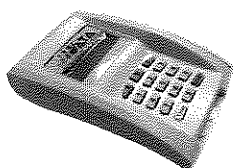

ATA's programming tool



Programming Pad

Particular conditions of installation

The modalities of installation of the taximeter shall be done in accordance with the national regulations.

Only ATA's brand printers are compatible with the taximeter ATA REVOLUTION.

Particular conditions of verification

Verification methods applicable to installed instruments depend on the applicable national regulations.

Annex to the OIML certificate n° R21/2007-FR02-2015/01 rev. 2

Error messages

SCREEN CODE	DESCRIPTION
[CODE_MESS_DEFAULT]	Fault message position
[CODE_MESS_DEF_CAI]	Anomaly of sensor signal: instant acceleration
[CODE_MESS_DEF_CAM]	Anomaly of sensor signal: mean acceleration
[CODE_MESS_DEF_CU]	Anomaly of sensor signal: sudden acceleration
[CODE_MESS_DEF_CP]	Anomaly of sensor signal: disturbance
[CODE_MESS_DEF_CT]	Anomaly of sensor signal: amplitude
[CODE_MESS_DEF_CIH]	Anomaly of sensor signal: high level impedance
[CODE_MESS_DEF_CIB]	Anomaly of sensor signal: low level impedance
[CODE_MESS_DEF_CIA]	Anomaly of sensor signal: stop impedance
[CODE_MESS_DEF_CS]	Anomaly of sensor signal: stability
[CODE_MESS_DEF_CL]	Anomaly of sensor signal: pulse width
[CODE_MESS_DEF_CR]	Anomaly of sensor signal: duty cycle
[CODE_MESS_DEF_CANBUS]	Anomaly of sensor signal: CAN Bus
[CODE_NOTIF_PB_IMP]	Anomaly of printer: connection problem or missing paper
[CODE_MESS_DEF_LA]	Anomaly of removable roof light: missing roof light
[CODE_MESS_DEF_LE]	Anomaly of removable roof light: disconnected during a trip
[CODE_MESS_DEF_LU]	Anomaly of removable roof light: Unrecognized device
[CODE_NOTIF_PB_LUM]	Anomaly of roof light
[CODE_NOTIF_PB_PILE]	Anomaly of internal battery

Software (in regard of WELMEC 7.2)

- Software version of the ATA BOX: BM01-xxxx-xx.xx (where xx are non-legally relevant information)
- Checksum : 48213 (type CRC 16) ;
- Type : P
- Class of risk : D
- Extensions : L, T, D, S and I7 ;
- Reference to the documentation submitted for type examination : « Notice descriptive du boîtier métrologique»;
- Instructions of how to check the identification of software: The visualization of the legal parameters is identified by the words [CODE_MESS_CRC_BM] for the ATA BOX & [CODE_MESS_CRC_ECR] for the screen in the management functions menu.
- The identification of the software of the screen is described in the specific appendix. His conformity is checked by the software of the ATA Box.

All other values different than the ones mentioned above must be considered as a broken seal.

Securing and sealing

• **ATA BOX**

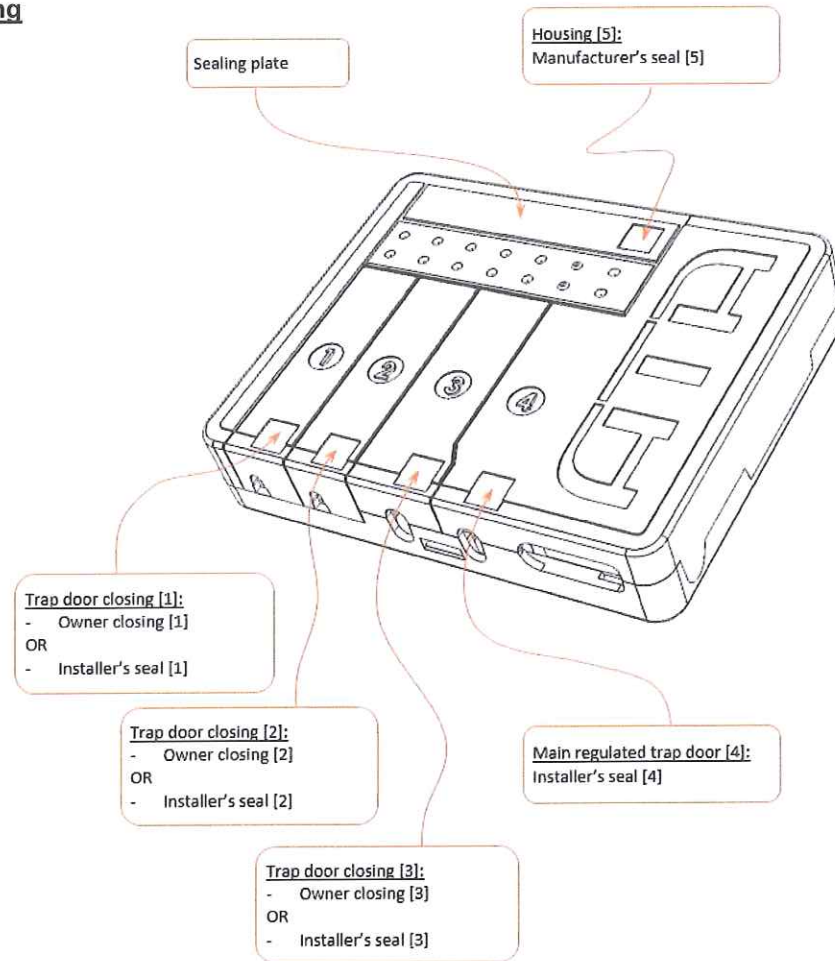

• **ATA screen**

The modalities of sealing applicable for each type of screen are specified in the appropriate Appendix.

Marking and inscriptions

The following statutory inscriptions appear on sealing plate for the regulatory registration of the ATA BOX:

- type of the instrument (REVOLUTION) ;
- the name of the manufacturer (ATA);
- the EC design certificate number of the instrument ;
- the k constant range in impulsion by km;
- the metrological EC marking;
- the serial number of the instrument.

Appendix 1: Screen Lite Pad

• **Constitution**

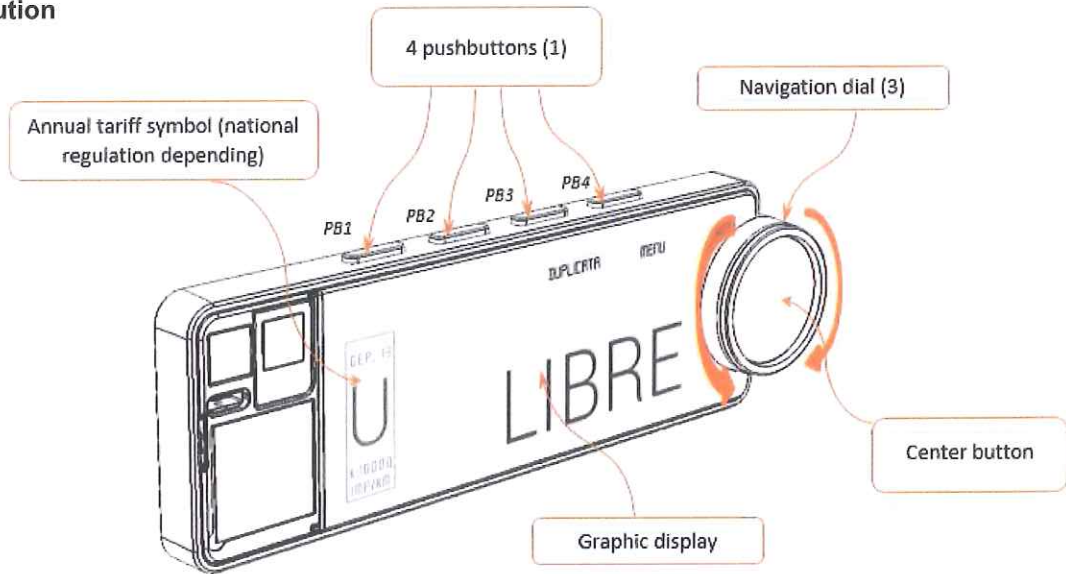

• **Functionality**

To start a journey from the position “FREE”, you have to push on the center button. The taximeter is on “FARE”. The rate change is effected by turning the dial to the left or right.

To finish the journey, you have to perform a long press on the center button. The taximeter switches to position "STOPPED". It is not possible to switch to position "FREE" before the extinguishing of the pictogram 🚗.

Printing the receipt is obtained by selecting the “RECEIPT” menu . The pictogram 🖨️ is displayed during the printing. In case of printer’s anomaly, the default is mentioned by the pictogram 🖨️❌

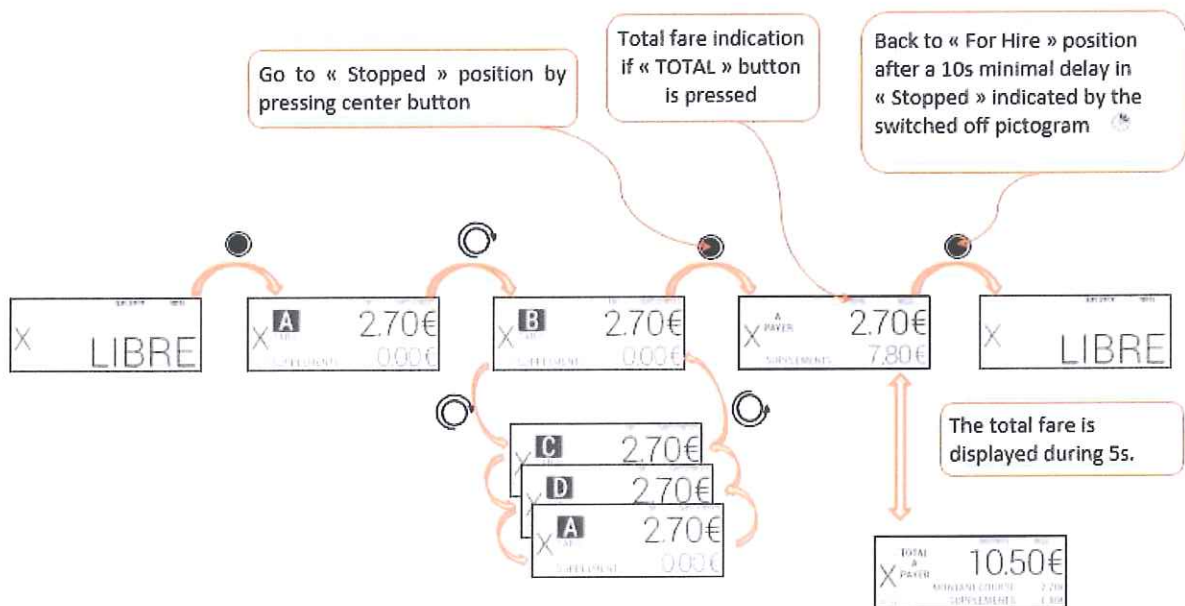

Annex to the OIML certificate n° R21/2007-FR02-2015/01 rev. 2

- **Securing and sealing**

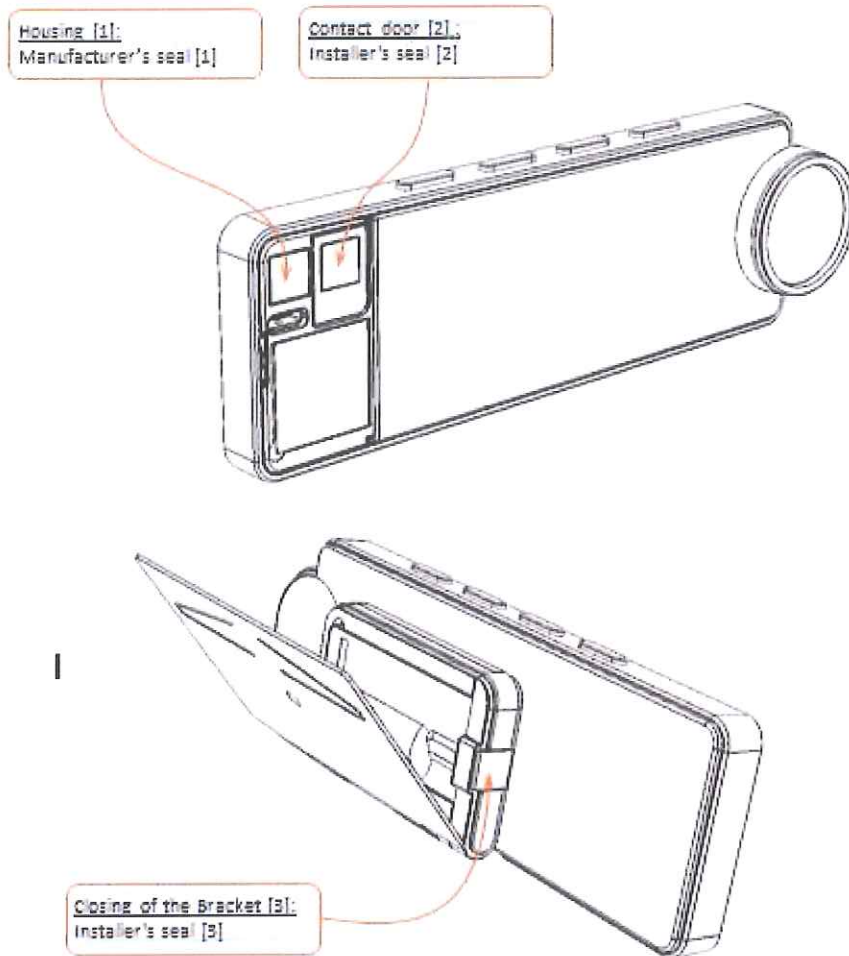

- **Software version:** LP01-xx.xxx.xx (xx are non-legally relevant)

- **Particular conditions of installation**

The fixing of the screen could be made in two way:

- By means of a robust mechanical fixing (screw for example),
- OR by a mean of fixing that can be removed without degradation of the dashboard (i.e. double sided adhesive tapes). In this case, this fixing mode must be completed by the use of the electronic sticker ATA. This label allows the taximeter to control the position of his bracket has not changed. This provision can be applied only in accordance with the applicable national legislation

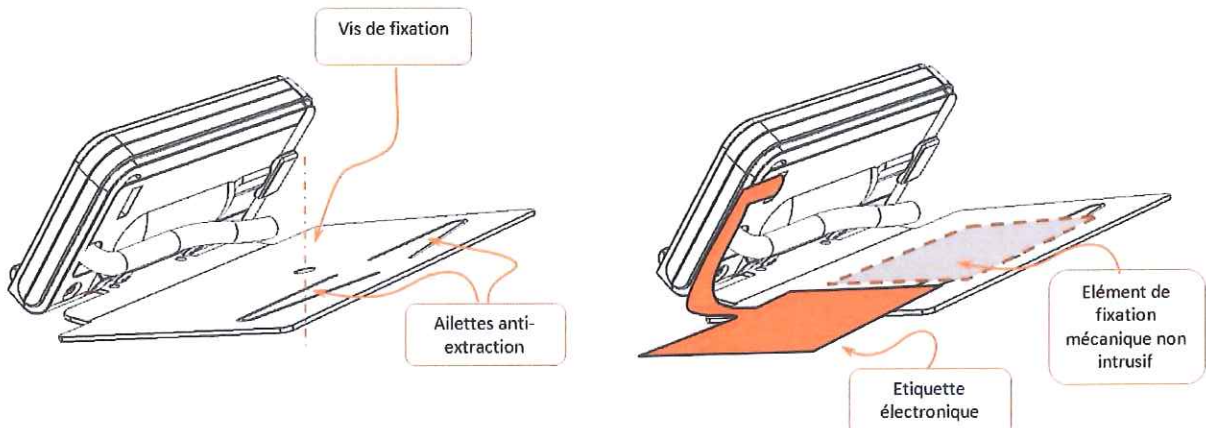

Appendix 2: screen PowerUP

• **Constitution**

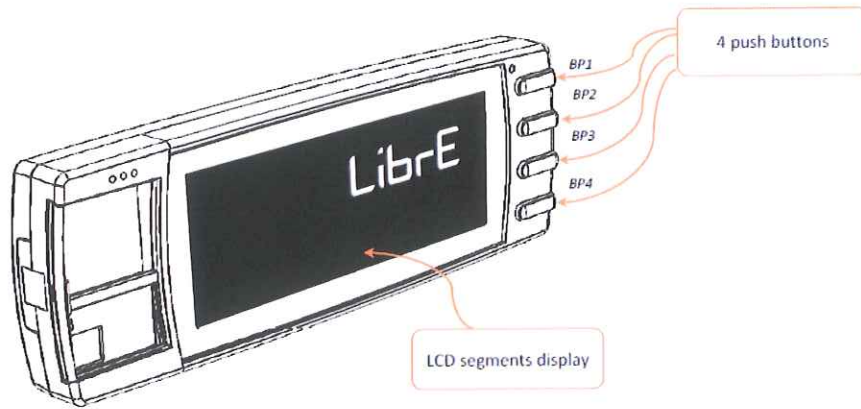

• **Functionality**

To start a journey from the position "FREE", you have to push the button BP1. The taximeter is on "FARE". The rate change is obtained by pushing the button BP1.

To finish the journey, you have to press for 1 second the button BP4. The taximeter switches to position "STOPPED". It is not possible to switch to position "FREE" before the extinguishing of the pictogram ⌚.

Printing the receipt is obtained by pushing the button BP3. In case of printer's anomaly, the default is mentioned by the pictogram 🖨️.

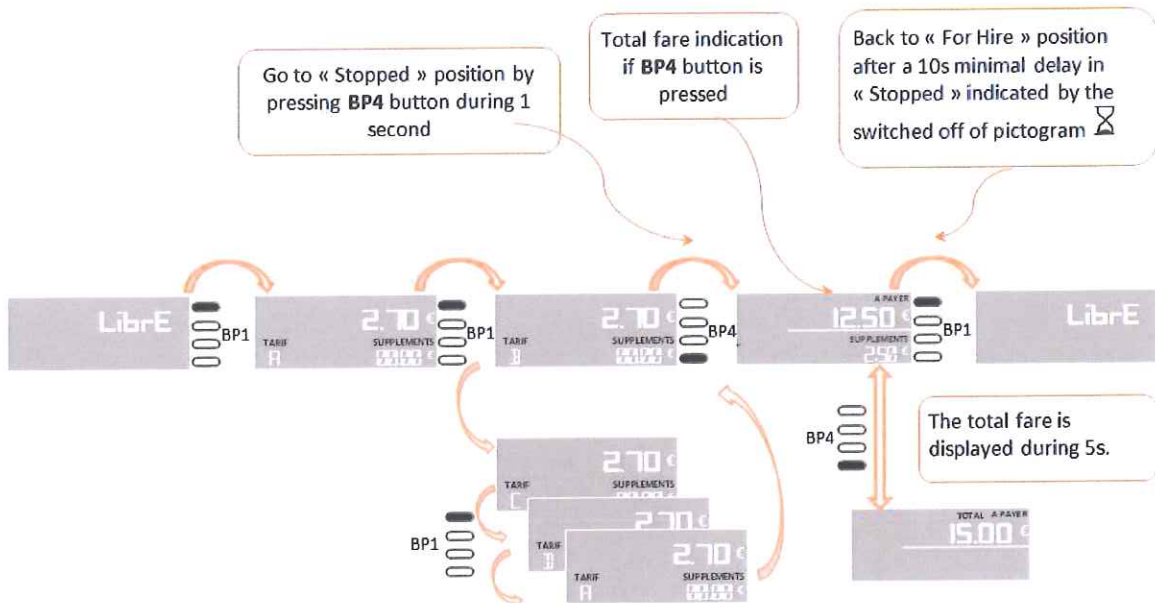

- **Securing and sealing**

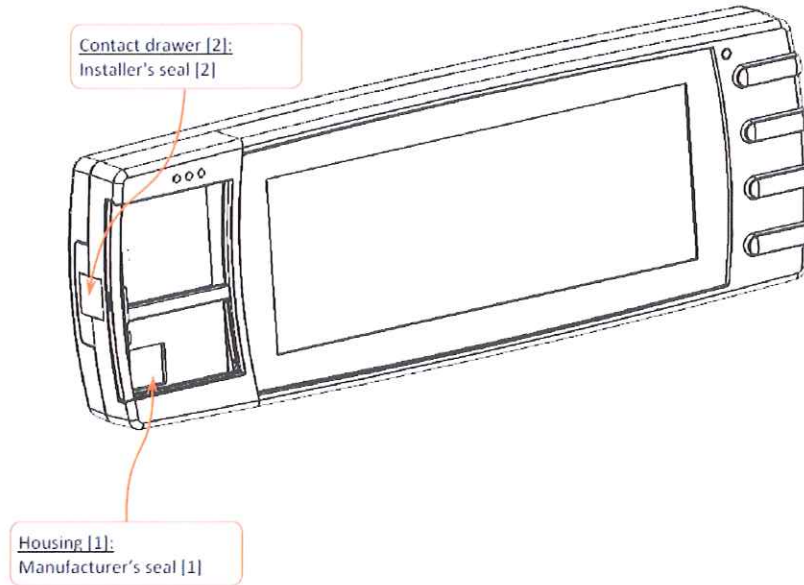

- **Software version:** MH01-xxxx-xx.xx (xx are non-legally relevant)
- **Particular conditions of installation**

The fixing of the screen could be made by a fixing crew and anti-extraction fins.

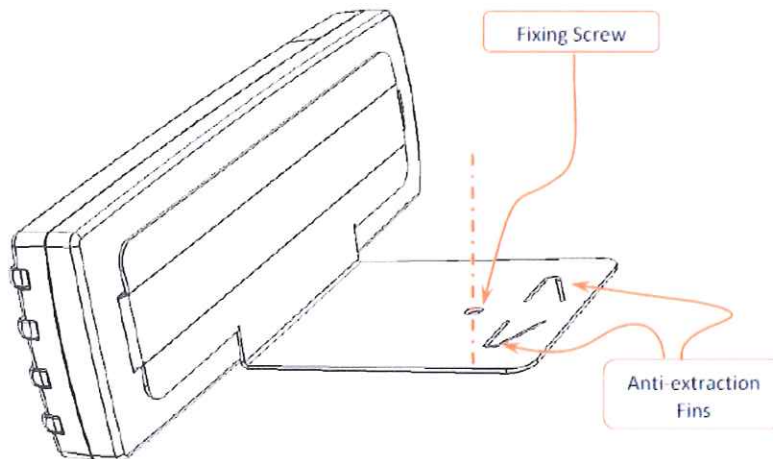

Appendix 3: Screen Air S

• **Constitution**

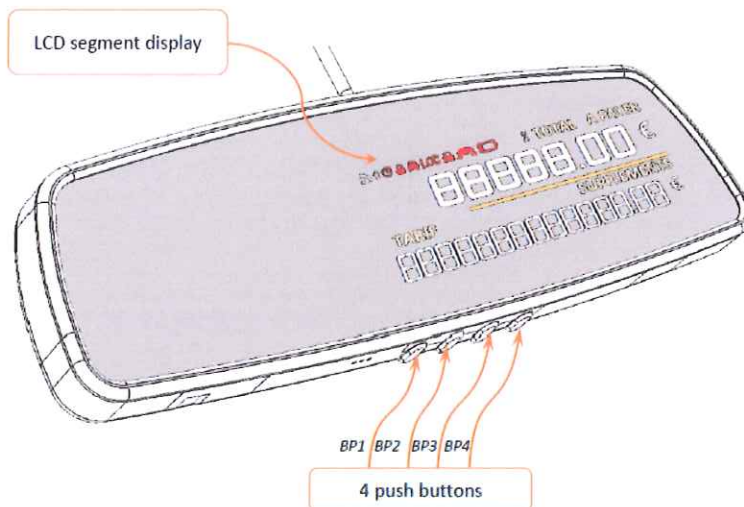

• **Functionality**

To start a journey from the position "FREE", you have to push the button BP1. The taximeter is on "FARE". The rate change is obtained by pushing the button BP1.

To finish the journey, you have to press for 1 second the button BP4. The taximeter switches to position "STOPPED". It is not possible to switch to position "FREE" before the extinguishing of the pictogram ⌚.

Printing the receipt is obtained by pushing the button BP3. In case of printer's anomaly, the default is mentioned by the pictogram 🖨️.

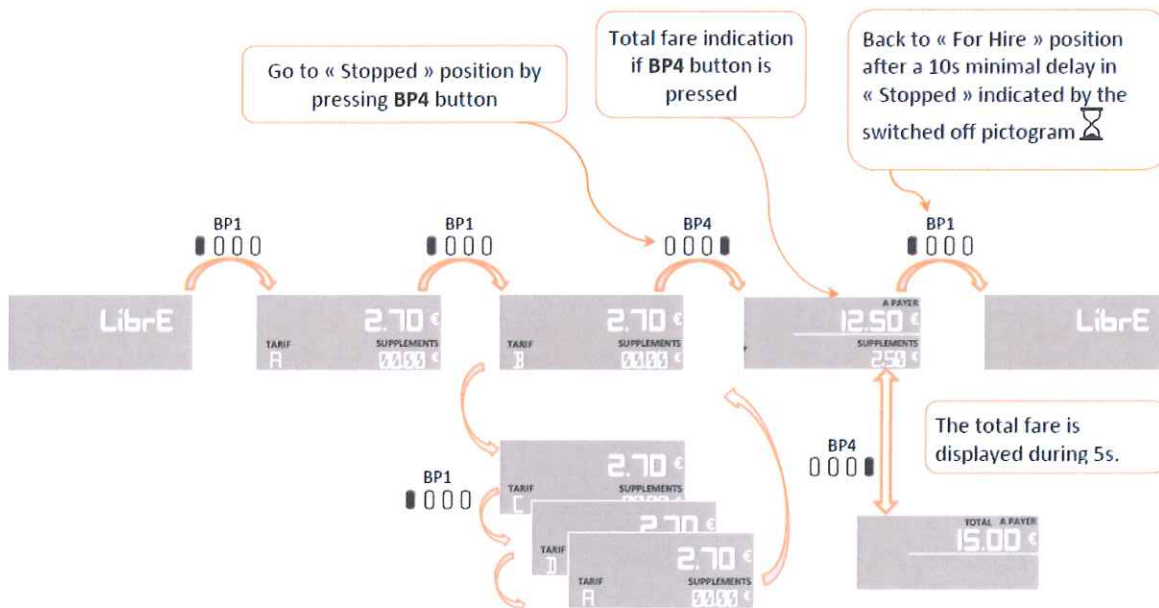

- **Securing and sealing**

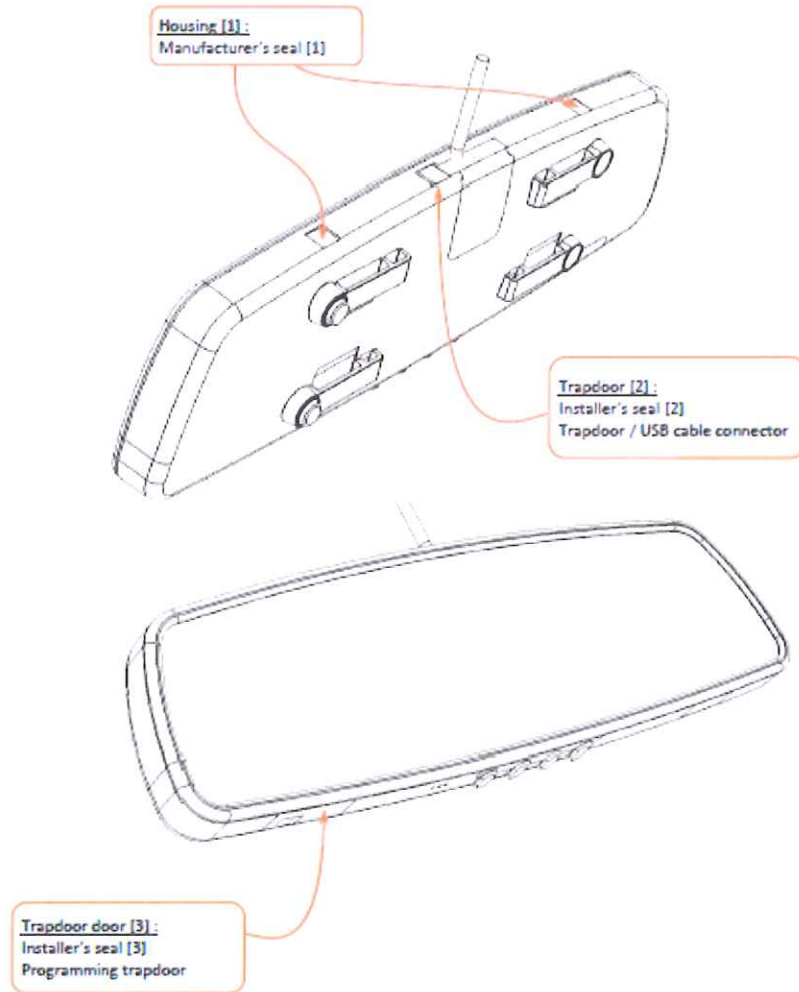

- **Software version:** RS01-xxxx-xx.xx (xx are non-legally relevant)
- **Particular conditions of installation**

The screen AIR S has to be hooked to the rearview mirror in conformity with the national requirements.

Appendix 4: Screen Air W

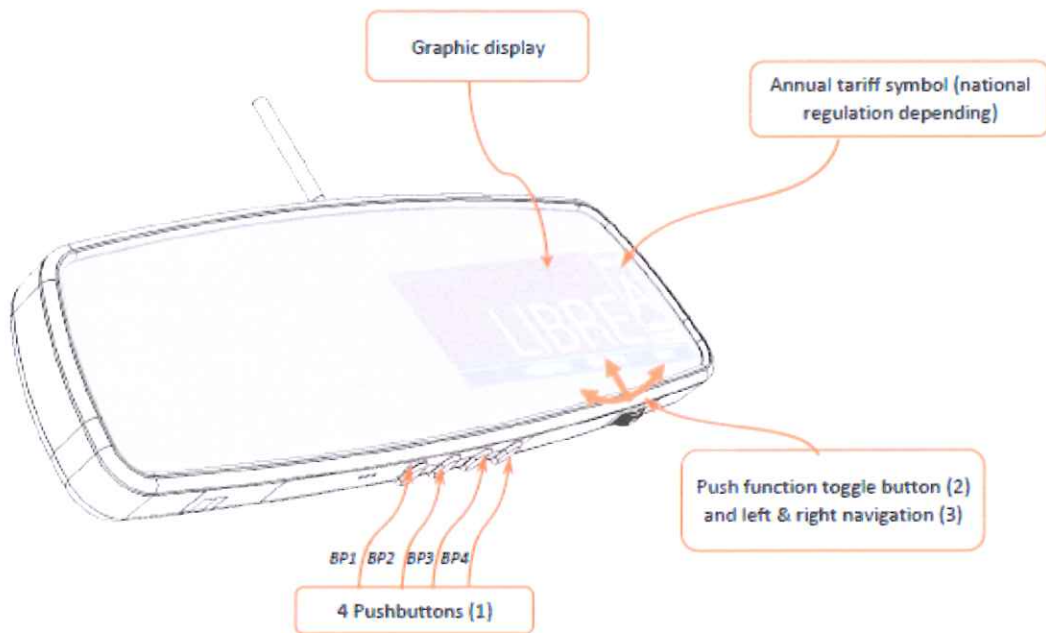

• **Constitution**



• **Functionality**

To start a journey from the position "FREE", you have to push on the center button. The taximeter is on "FARE". The rate change is effected by turning the dial to the left or right.

To finish the journey, you have to perform a long press on the center button. The taximeter switches to position "STOPPED". It is not possible to switch to position "FREE" before the extinguishing of the pictogram .

Printing the receipt is obtained by selecting the "RECEIPT" menu. The pictogram  is displayed during the printing. In case of printer's anomaly, the default is mentioned by the pictogram .

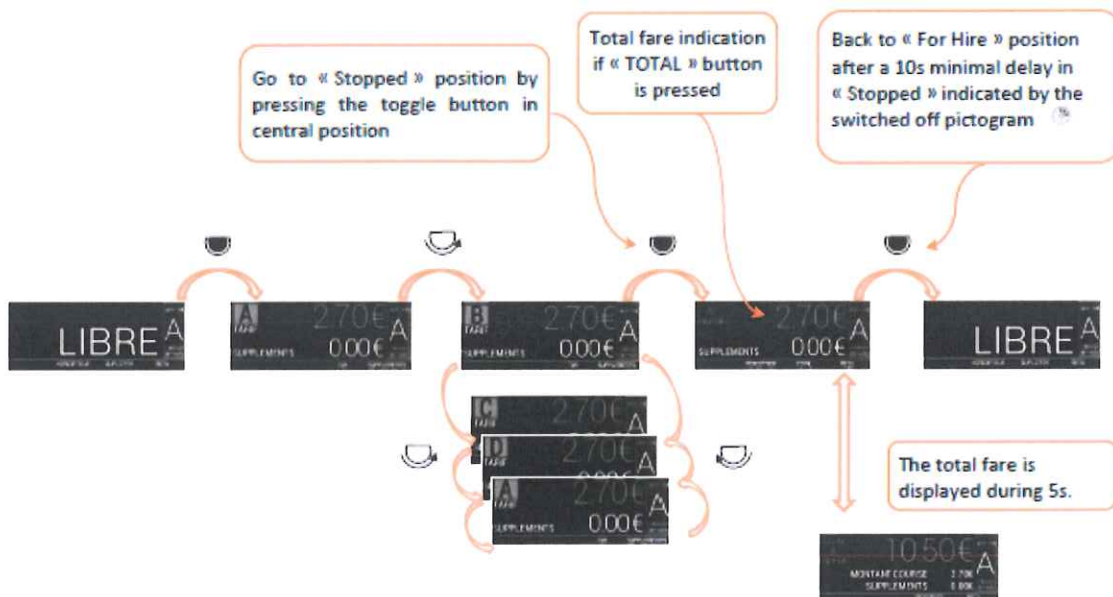

- **Securing and sealing**

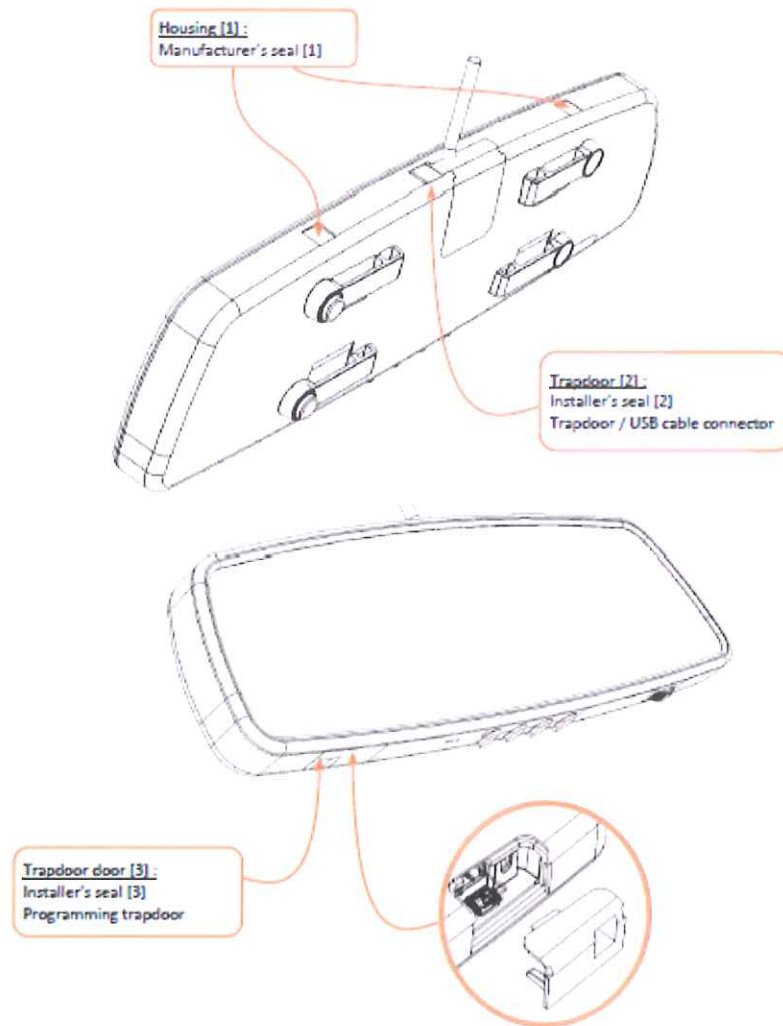

- **Software version:** RW01-xxxx-xx.xx (xx are non-legally relevant)
- **Particular conditions of installation**

The screen AIR W has to be hooked to the rearview mirror in conformity with the national requirements.

Appendix 5: conditions for the compatibility and securing between the taximeter and the ATA Cardan generator

• **Constitution**

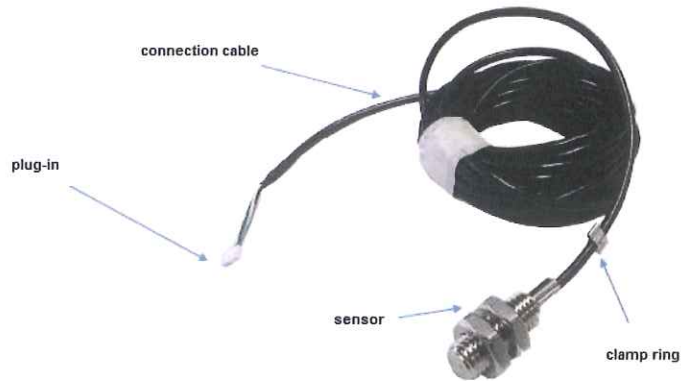

• **Functionality**

The principle of operation of the ATA Cardan generator is based on the use of a magnetoresistive sensor which detects the passage of a magnet in close proximity. From this sensor, an unshielded cable transports the electrical signals to the taximeter.

• **Securing and sealing**

The cable of the ATA Cardan generator includes a plug-in which is connected under the main regulated trap door (reserved to the installer). The connection is protected by the installer's seal on the closure of the ATA BOX trap door.

A beaded wire sealed by a lead or plastic disc protects the installation of the ATA Cardan generator

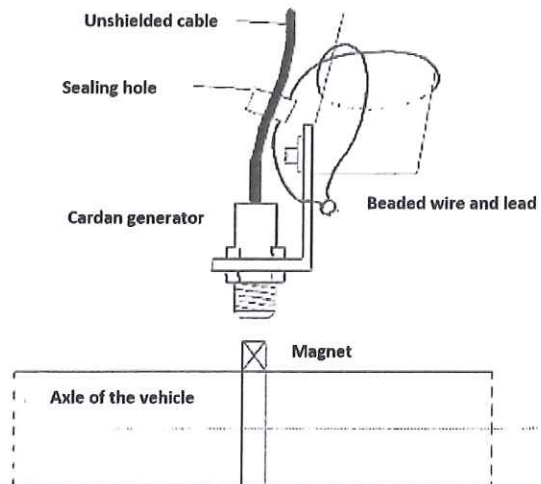

• **Particular conditions of installation**

The ATA Cardan generator can be installed with one or two magnets. The k factor minimal value for the taximeter is 500 pulses by km, it is required to use two magnets for vehicle with a wheel circumference exceeding 2 meters. If the generator is installed with two magnets, these ones must be arranged at diametrically opposed positions on the drive shaft or the cardan. A tolerance of magnet arrangement is allowed in order to facilitate the installation (25°).

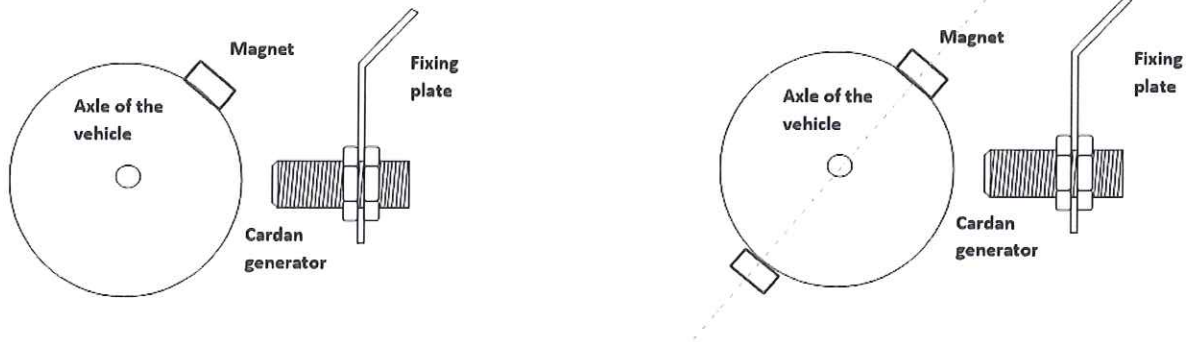

Annex to the OIML certificate Nr. R21/2007-FR02-2015/01 rev 1

The maximum distance between the magnets on the drive shaft and the sensor is 10 mm.